

Data sheet | Item number: 722-233/005-000/039-000

Female connector for rail-mount terminal blocks; angled; 100% protected against mismatching; Locking lever; Pin spacing 5 mm; 3-pole

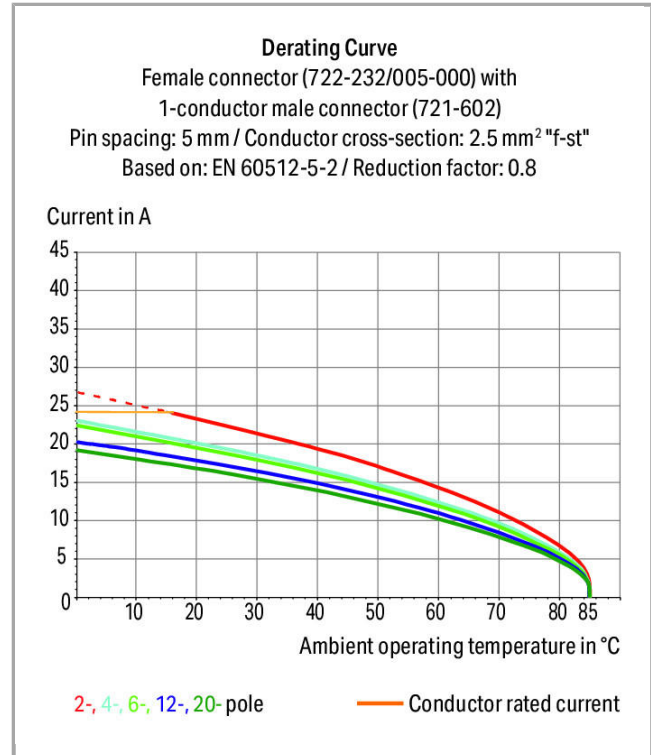

722-233/005-000/039-000

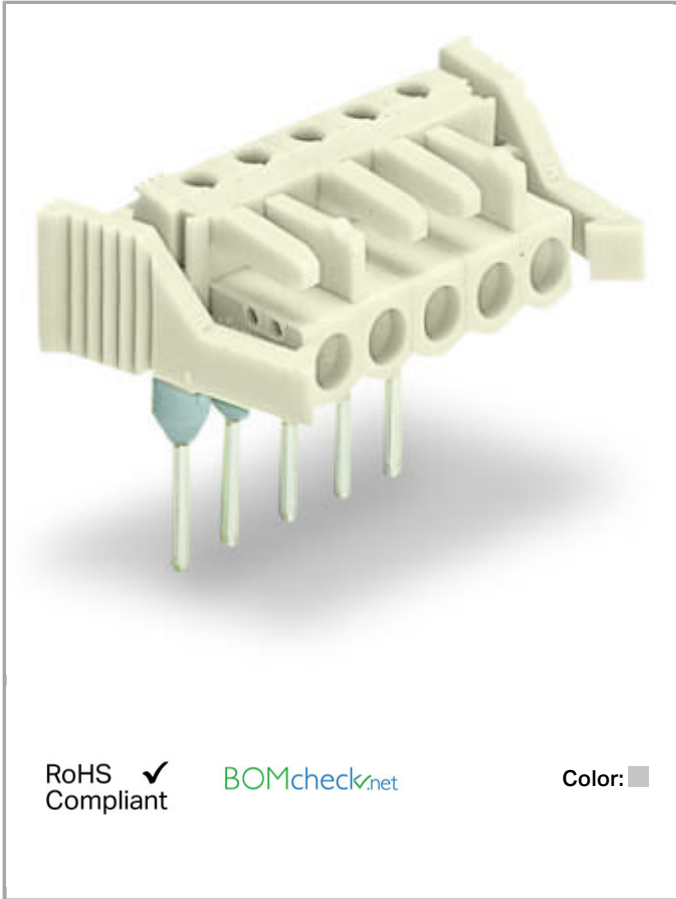

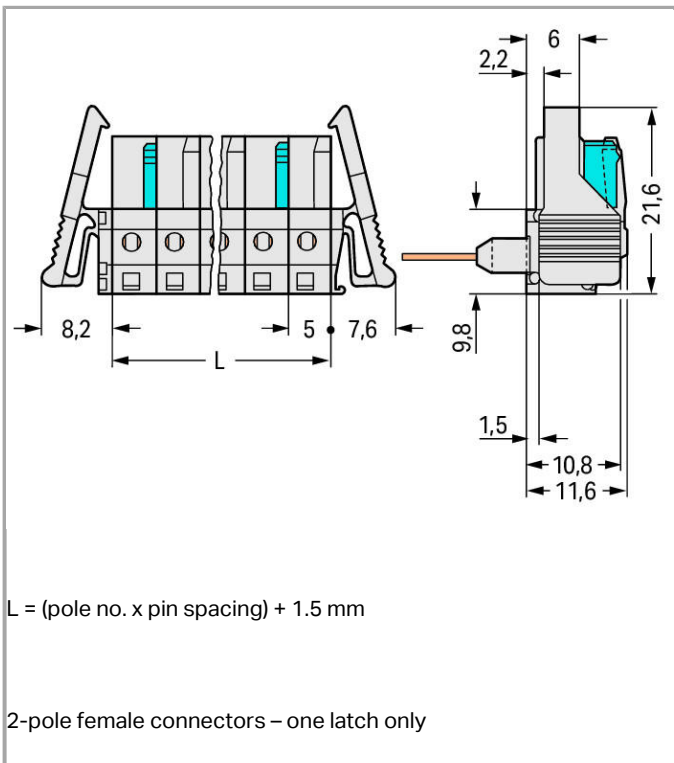

Item description

- Pluggable connectors for rail-mount terminal blocks equipped with CAGE CLAMP® connection
- Female connectors with long contact pins connect to the termination ports of 280 Series Rail-Mount Terminal Blocks
- Female connectors are touch-proof when unmated, providing a pluggable, live output
- 100 % protected against mismatching
- With coding fingers

Safety information 1:

The *MULTI CONNECTION SYSTEM (MCS)* is designed without breaking capacity for compliance with DIN EN 61984. When used as intended, MCS Connectors shall not be connected/disconnected when live or under load. The circuit design should ensure header pins, which can be touched, are not live when unmated.

Data

Electrical data

Ratings per IEC/EN 60664-1

Rated voltage (III / 3)	320 V
Rated impulse voltage (III / 3)	4 kV
Rated voltage (III / 2)	320 V
Rated impulse voltage (III / 2)	4 kV
Rated voltage (II / 2)	630 V

Rated impulse voltage (II / 2)	4 kV
Rated current	12 A

Approvals per UL 1059

Rated voltage UL (Use Group B)	300 V
Rated current UL (Use Group B)	15 A
Rated voltage UL (Use Group D)	300 V
Rated current UL (Use Group D)	10 A

Approvals per UL 1977

Rated voltage per UL 1977 (factory wiring only)	600 V
Rated current per UL 1977 (factory wiring only)	15 A

Approvals per CSA

Rated voltage CSA (Use Group B)	300 V
Rated current CSA (Use Group B)	15 A
Rated voltage CSA (Use Group D)	300 V
Rated current CSA (Use Group D)	10 A

Connection data

No. of poles	3
Total number of potentials	3
Number of connection types	1
Number of levels	1

Geometrical Data

Pin spacing	5 mm / 0.197 inch
Width	30.8 mm / 1.213 inch
Height	26.1 mm / 1.028 inch
Height from the surface	11.6 mm / 0.457 inch
Depth	18.25 mm / 0.719 inch

Plug connection

Contact type (pluggable connector)	Female connector/socket
Connector connection type	for front-entry wiring terminal block
Mismating protection	Yes
Locking of plug-in connection	locking lever
Steckrichtung zur Reihenklemme	0°

Material Data

Color	light gray
Material group	I
Insulating material	Polyamide 66 (PA 66)
Flammability class per UL94	V0
Contact material	Copper alloy
Contact plating	tin-plated
Fire load	0.081 MJ
Weight	4.1 g

Environmental Requirements

Limit temperature range	-60 ... +85 °C
-------------------------	----------------

Commercial data



Product Group	3 (Multi Conn. System)
Country of origin	DE
GTIN	4044918572439
Customs Tariff No.	85366990990

Approvals / Certificates

Country specific Approvals





Logo	Approval	Additional Approval Text	Certificate name
	CSA DEKRA Certification B.V.	C22.2	1466354

UL-Approvals



Logo	Approval	Additional Approval Text	Certificate name
	UR UL International Germany GmbH	UL 1977	E45171
	UR UL International Germany GmbH	UL 1977	E45171

Compatible products

General accessories

	Item no.: 280-650/056-000 Spacer of same profile; suitable for 3-conductor terminal blocks of horizontal type	/У56-УУУ	280-650
	Item no.: 280-654/056-000 Spacer of same profile; suitable for 3- and 4-conductor terminal blocks of angled type	/У56-УУУ	280-654
	Item no.: 280-835/056-000 Spacer of same profile; suitable for 4-conductor terminal blocks of horizontal type	/У56-УУУ	280-835
	Item no.: 280-902/056-000 Spacer of same profile; suitable for 2-conductor terminal blocks of horizontal type	/У56-УУУ	280-902

check

	Item no.: 210-136 Test plug; 2 mm Ø; with 500 mm cable		210-136
	Item no.: 210-137 Test plug; 2.3 mm Ø; with 500 mm cable		210-137
	Item no.: 231-661 Test plugs for female connectors; for 5 mm and 5.08 mm pin spacing		231-661

tools

	Item no.: 280-433 Operating tool; of insulating material; 3-way		280-433
--	---	--	---------

Downloads

CAD/CAE - Smart Data

CAD data

3D Download 722-233/005-000/039-000	URL	Download
-------------------------------------	-----	----------

Subject to changes.